

SECTION B-B

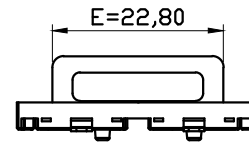

SECTION A-A

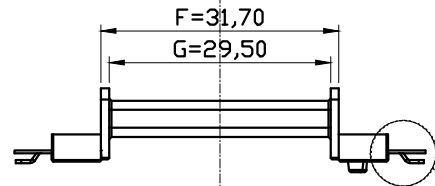
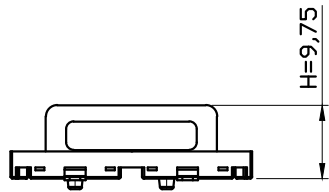
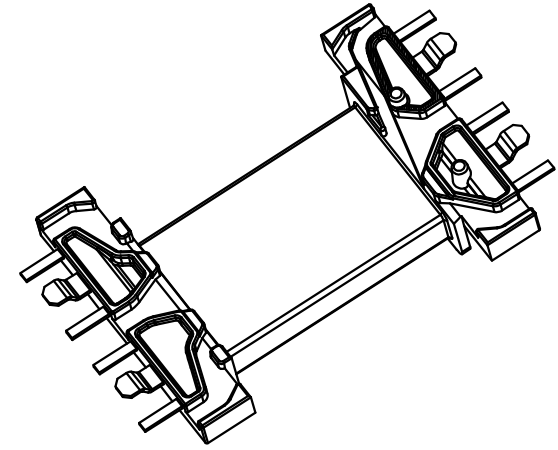
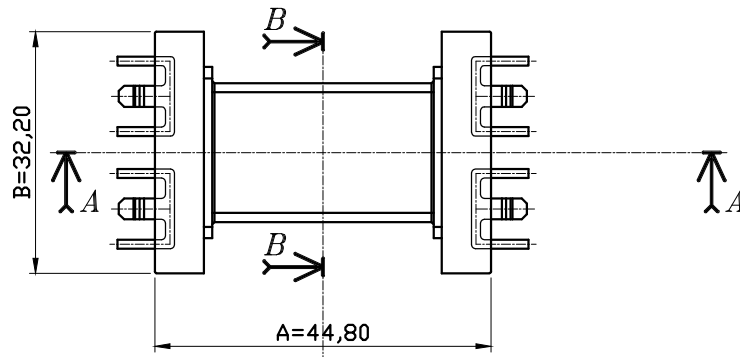
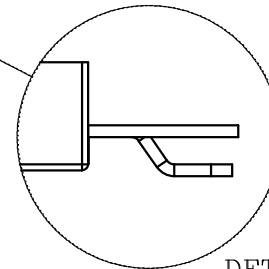

DETAIL S=4/1

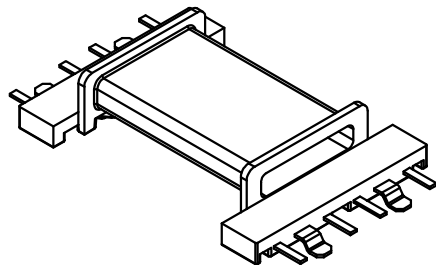
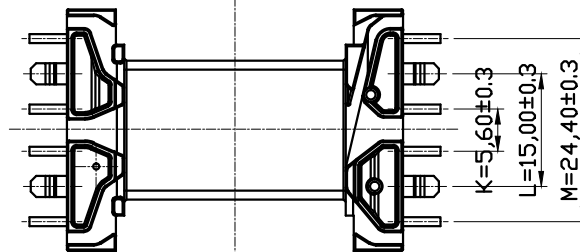

▲					
▲					
▲					
▲					

MARK	REVISION NOTE			DATE	DRAWN	CHECKED	APPROVED
DRAWN	CHECKED	APPROVED	MATERIAL : L.C.P	UL REC. : UL94V-0	THIRD ANGLE PROJ.	SCALE : 1/1	
D M ,Choe	G Y, Lim	J B, Lim	Z : PIN LENGTH (According to customer's request)	DATE : 2011.07.29	TOLERANCE : ±0.2 (Unless otherwise specified)		UNIT : m/m
주식회사 대흥보빈 DAE HEUNG BOBBIN CO., LTD			TITLE EFD 34*44 BOBBIN (A)		DWG NO DH-111111-8629-00		